

# KOMATSU®

## PC210-10M0 PC210LC-10M0

 **L&T CMB NATIONWIDE DEALER NETWORK**



**EQUIP-CARE**  
Customer Care Number  
**1800 833 9990**

Unified program for  
sales & after sales support.

Product improvement is a continuous process. Specifications given in this publication are therefore subject to change without notice.  
Photographs depicted may be of optional equipment

[www.komatsuindia.in](http://www.komatsuindia.in)

Printed on 02-2020

**KOMATSU®**

Marketed & Serviced by:



**L&T Construction & Mining Machinery**

**Larsen & Toubro Limited**

1<sup>st</sup> Floor Lakshminarayan Complex, 10/1 Palace Road, Bengaluru- 560 052

Tel: 080 40401700 / 900

E-mail: [ceb@larsentoubro.com](mailto:ceb@larsentoubro.com) [www.lntcmb.com](http://www.lntcmb.com)

**Zonal Offices:**

**Delhi** (011) 40819500  
**Nagpur** (0712) 6606441/2260025  
**Jaipur** (0141) 4385900

**Kolkata** (033) 44002433/22831442  
**Hyderabad** (040) 47575064

**Pune** (020) 48544259  
**Chennai** (044) 40706864

CIN: L99999MH1946PLC004768

Materials and specifications are subject to change without notice.  
**KOMATSU** is a trademark of Komatsu Ltd. Japan.

# PC210

HYDRAULIC EXCAVATOR



Photos may include optional equipment.

VARIANTS & OPERATING WEIGHT

**STD** 20.9 T to 21.4 T | **LC** 22 T | **HD** 23.1 T

GROSS HP: 123 kW 165 HP/2000 min<sup>-1</sup> NET HP: 123 kW 165 HP/2000 min<sup>-1</sup>

BUCKET CAPACITY: 0.85 / 1.0 / 1.1 / 1.2 / 1.7 m<sup>3</sup>

# Higher Returns. Peace of Mind.



Photos may include optional equipment.

PC210/210LC-10M0



### HIGHER DURABILITY

- Enhanced work equipment
- Heavy-duty main frame
- Improved swing circle rigidity

### INFORMATION & COMMUNICATION TECHNOLOGY (ICT) & KOMTRAX

- Large high resolution Liquid Crystal Display (LCD) monitor
- Equipment Management & Monitoring System
- KOMTRAX Facility

↓ 20%

### LOWER FUEL CONSUMPTION

- Reduction of fuel consumption by 20% (Compared to the PC210-8M0)
- Advanced management system of variable engine speed matching control
- Viscous fan clutch system
- Reduction of hydraulic loss in pipes and tubes

↑ 20%

### HIGHER PRODUCTIVITY

- Larger bucket capacity
- Higher stability
- Powerful digging operation
- Improved travel performance

### SAFETY & COMFORT

- Large comfortable cab
- ROPS Cab (ISO 12117-2) (Optional)
- Rear view monitor system (Optional)

### LOWER MAINTENANCE COST

- Less maintenance time
- Early warning and detection system for preventive repairs
- Visually impressive maintenance information on the monitor screen

Photos may include optional equipment.



# HIGHER PRODUCTIVITY

PC210/210LC-10M0



Photos may include optional equipment.

## Increased Productivity

### Large capacity buckets

Bucket selection up to 1.20 m<sup>3</sup> are available. It can be matched for various applications.

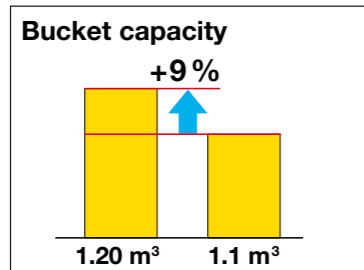

### Bucket capacity

**1.00 m<sup>3</sup> & 1.20 m<sup>3</sup>**

### 1.20 m<sup>3</sup> ME bucket

By optimizing the shape of the side edge, it increases the penetration force. ME bucket profile increases production and optimises fuel consumption and wear reduction.



### Excellent stability

Stability is substantially improved by increasing the weight of counterweight and extending the rear end radius compared with PC210-8M0. Lifting capacity is increased by 5%. This makes the operation smooth even being equipped with large capacity bucket and heavy attachment.

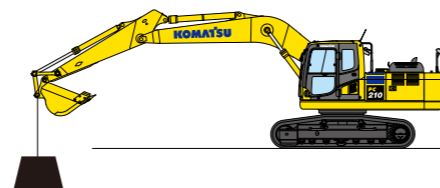
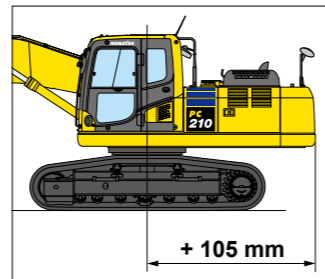

### Lifting capacity

Compared to the PC210-8M0

**5% up**

### Powerful digging operation

Digging in P mode has become powerful by improving hydraulic controls. When more power is needed, the engine output is powered up by the one-touch power max. function and you can dig stronger. Increasing engine power achieves high performance.

### Digging power (One-touch power max. function)

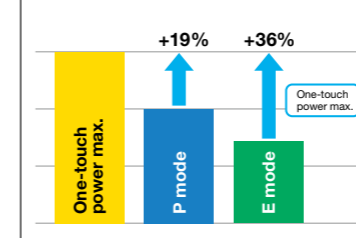

### Engine power

**12% up (123 kW ← 110 kW)**

Compared to the PC210-8M0

### One-touch power max. function

Digging force increases for 8.5 seconds of operation when left knob switch called one-touch power max switch is continuously pressed. You can normally use E mode to reduce fuel consumption. Use this function only when needing extreme digging power temporarily, even more than P mode.



One-touch power max. switch

### Powerful travelling performance

Increased engine power makes the travelling in P mode powerful. When you are travelling on a high-load uphill or uneven terrain, PC210-10M0 gives you stable speed and smooth travelling. Improved travel performance in Granite and Marble application.

### Traveling output power

**15% up**

Compared to the PC210-8M0



Photos may include optional equipment.



# LOW FUEL CONSUMPTION

PC210/210LC-10M0

## KOMATSU NEW ENGINE TECHNOLOGIES

### Low Fuel Consumption Technology

Engine management is enhanced. The variable speed matching of the engine, hydraulic pump and a viscous fan clutch guarantee efficiency and precision. Through the in-house development and production of main components, Komatsu has achieved great advancements in technology, providing high levels of performance and efficiency in virtually all applications.

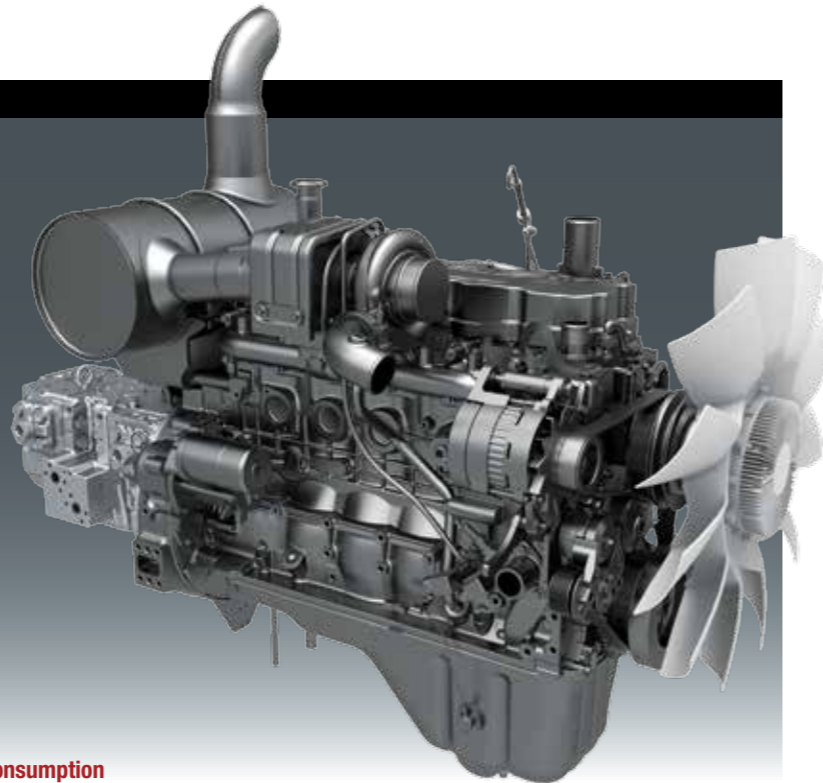

Komatsu SAA6D107E-1 engine  
EU Stage 3A equivalent  
(CG image)

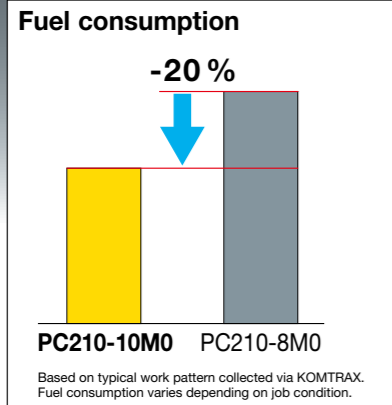

### Fuel consumption

**20% better**  
(Compared to the PC210-8M0)

Fuel consumption varies depending on job condition.

### Improvement of engine combustion efficiency

By optimizing the fuel injection control, the engine combustion efficiency has improved. This technology has achieved both high power output and low fuel consumption.

### Reduction of hydraulic pressure loss

The internal shape of the control valves, piping diameter and fitting shape have been thoroughly revised. With this improvement, hydraulic loss is reduced and contributes to low fuel consumption.

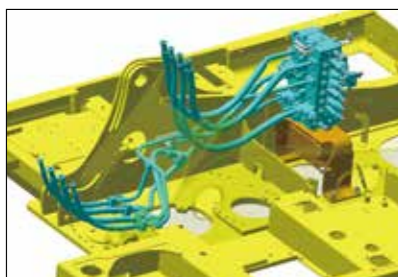

### Reduced fan speed and fan drive loss

A speed controlled viscous fan clutch and large diameter fan improves engine efficiency and reduces engine power requirements when operating in cooler temperatures.



### Enhanced engine-pump matching control

Large displacement hydraulic main pumps provide high flow output at low engine RPM. Further, by building in optimum matching of the engine and pump, it keeps high operability and workability. This technology achieves high production and low fuel consumption.

### Assists Energy-saving Operations

#### ECO gauge

Equipped with the ECO gauge that can be recognized at a glance on the right of the multi-function color monitor for environment-friendly energy-saving operations. Allows focus on operation in the green range with reduced CO<sub>2</sub> emissions and efficient fuel consumption.



ECO gauge Idling caution

#### Idling caution

To prevent unnecessary fuel consumption, an idling caution is displayed on the monitor, if the engine idles for 5 minutes or more.



Photos may include optional equipment.

## Fuel Saving Support Functions

### Select a working mode that suits your purpose

In P mode, LARGE PRODUCTION and in E mode, LOW FUEL CONSUMPTION are implemented. E mode can be adjusted widely from E0 to E4 mode, and it adapts flexibly to customer's demands. Komatsu tuned each work mode precisely, ensuring high operability and workability. Just by selecting the work mode, it provides the best performance in demanding applications.

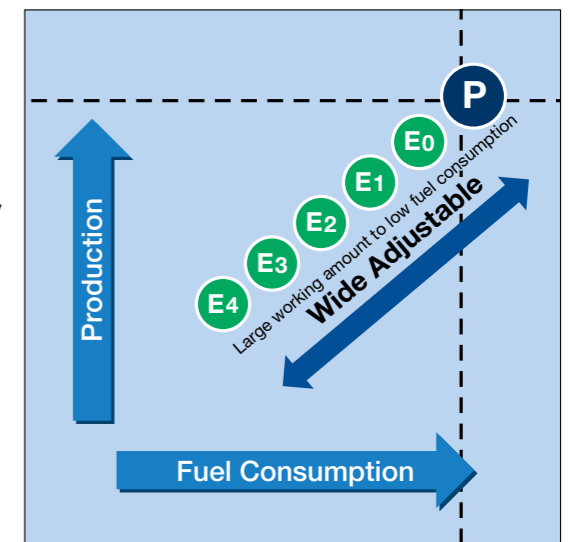

#### P (Power mode):

Maximum production  
Fast cycle time



#### E (Economy mode):

Better fuel consumption

#### Easy selectable E mode

Compared with the conventional model, E0 to E4 can be easily selected on the monitor.

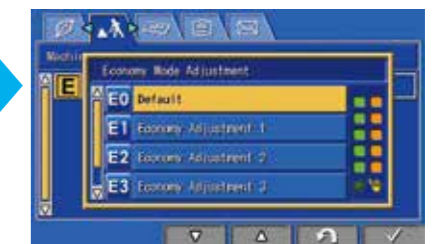
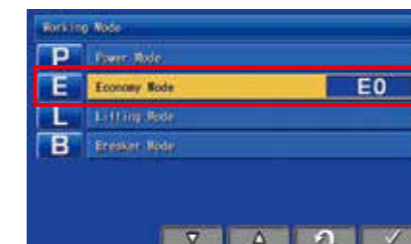

In addition to the above modes there are also the following modes. Please select the appropriate mode according to the application.

Working Mode	Application	Advantages
L	Lifting mode	<ul style="list-style-type: none"> <li>Suitable attachment speed</li> <li>Lifting capacity is increased 7% by raising hydraulic pressure.</li> </ul>
B	Breaker mode	<ul style="list-style-type: none"> <li>Optimum engine rpm, hydraulic flow</li> </ul>



# EASY MAINTENANCE, LOWER COST

## Komatsu pursued reduction of maintenance time and cost.

### Easy access to filters

Engine oil and fuel system filters are integrated into one side to allow easy maintenance and service.

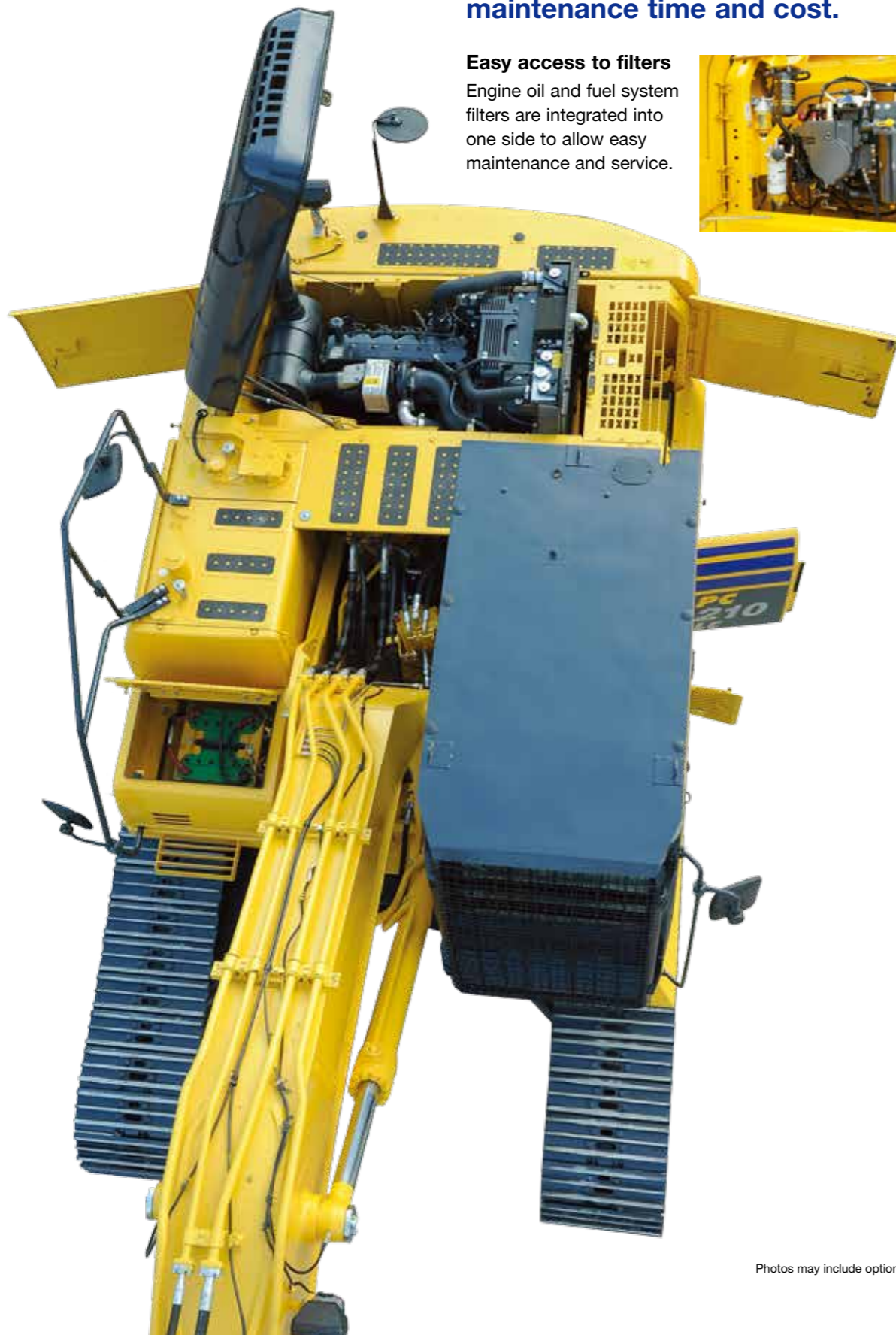

### Easy cleaning cooling unit

Cleanability of the cooling unit has been improved.

- Easier cleaning of the core by making the automatic air conditioner (A/C) capacitor a hinge structure
- Dust-proof net does not require tools for easy cleaning
- Making oil cooler a single piece from 2 pieces, no more space accumulating dust



### Easy oil sampling

Easy oil sampling ports are added. It is important to get sample that was agitated properly. Using this equipment will help in accurate analysis.



### Minimize breaking of circle grease nipple

The grease nipple of the circle is embedded for protection. It is irrefrangible structure even if wood debris or dusts are coiled around a swing circle.



### Clogging sensor for breaker line



Clogging hydraulic oil filter caution

### Easy maintenance time management

The monitor informs replacement time of oil and filters on the LCD when the replacement interval is reached.



### Extended replacement interval of hydraulic oil filter

The replacement interval of the hydraulic oil filter element is extended by 2.5 times. It contributes to reduction of maintenance cost.

**2500 Hrs**

**1000 Hrs**



### Easy to know maintenance time when using breaker

In addition to the above functions, it monitors the breaker usage time. Since the replacement time will be changed depending on the breaker usage time, monitor can notify the optimum replacement time.

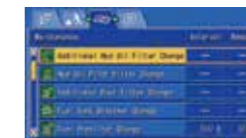

### Detect abnormality of hydraulic circuit clogging sensor for hydraulic oil as standard

When the hydraulic oil filter is clogged, the caution message pops up on the monitor to notify replacing the filter. This helps prevent the breakdowns and reduce repair cost.

### Fuel line contamination prevention

Fuel pre-filter removes water and contaminants in the fuel to prevent fuel problems (with built in priming pump).



### Pre-cleaner for dusty condition

Even in dusty places, by installing pre-cleaner coupled with the large air cleaner, the frequency of cleaning the air cleaner will be reduced. Durability has also improved by adopting new high efficiency pre-cleaner.



### Battery disconnect switch

A battery disconnect switch allows a technician to disconnect the power supply and lock out before servicing or maintenance of the machine. Also, minimize discharge of the battery during long-term non operation. System operating lamp indicates the timing when switch was disconnected to prevent controller failures.



### Other Features

- Easy cleaning drain port of fuel tank
- Improved drainability of hydraulic oil and fuel
- Easy to check level of hydraulic oil
- Blow-by pressure detection
- Fuel line contamination prevention

Photos may include optional equipment.



# HIGHER DURABILITY

**High Strength Work Equipment & Frames to work with large size bucket. It has Durability to Withstand Any Application.**

**Enhanced work equipment**  
Komatsu has built work equipment with increased durability in any application. It is a structure that endures the harsh test and incorporates highly accurate controlled welding technology. Ultrasonic inspection ensures quality.

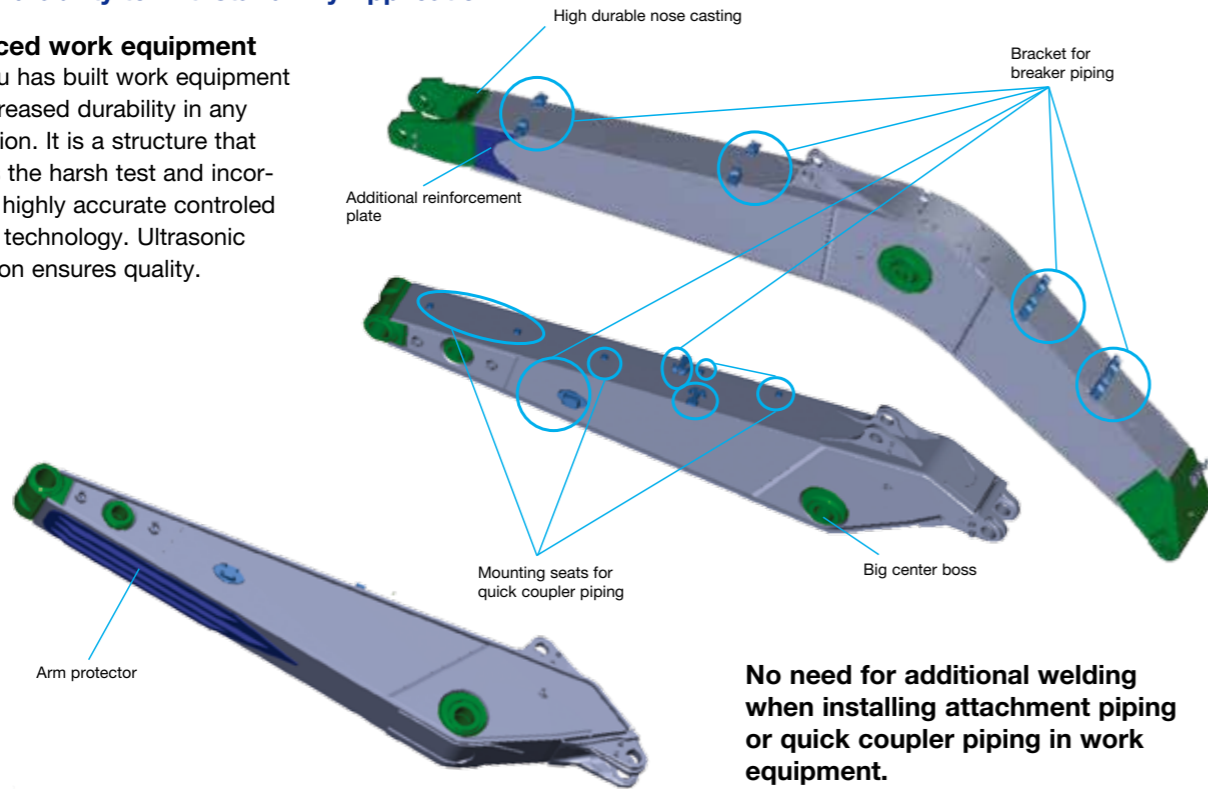

### Reinforced revolving frame

Main components are installed to revolving frame. Revolving frame is strengthened to withstand the stresses imposed by severe conditions at site. This tempered frame supports stable operation.

Bush is added in the boom foot mounting area in revolving frame to increase its durability.



### Strengthened swing circle

Swing circle with improved durability supports stable operation in any severe jobsite.

### Reliable Komatsu components

All of the major components, such as engine, hydraulic pumps, hydraulic motors and control valves are exclusively designed and manufactured by Komatsu.

### Track Frame Reinforcement

The reinforcement prevents the idler guide from opening and subsequently damaging the undercarriage components.



### Highly reliable electronic devices

Exclusively designed electronic devices have passed severe testing.

- Controllers
- Sensors
- Connectors
- Heat resistant wiring

### Sealed connector

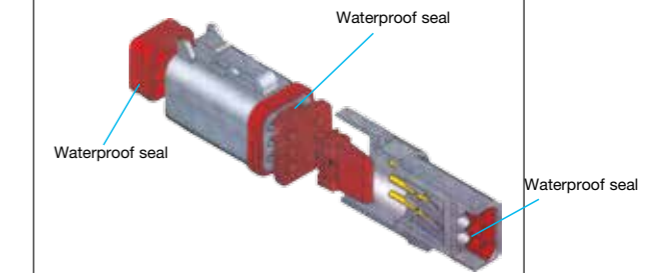

### HD Undercarriage (Optional)\*

HD (Heavy Duty) Undercarriage enhances life of undercarriage especially track shoe for Granite and Marble applications.

\* only available for PC210LC-10M0 (HD)

### Steady frame structure

The revolving frame, center frame and undercarriage are designed by using the most advanced three-dimensional CAD and Finite Element Method (FEM\*) analysis technology.

\* FEM analysis is a stress simulation method using a computer.

### Full length track roller guards (Optional)

The roller guards cover the entire track roller and prevent stones from getting lodged in track rollers, possible derailment of tracks and wear on track links and track rollers during turning.



# ICT & KOMTRAX

PC210/210LC-10M0

**LARGE HIGH RESOLUTION LCD MONITOR**

**Large High-Resolution LCD Monitor**  
A large user-friendly high resolution LCD color monitor enables safe, accurate and smooth work. Simple and easy to operate switches.

**Indicators**

1 Auto-decelerator	6 Fuel gauge
2 Working mode	7 ECO gauge
3 Travel speed	8 Fuel consumption gauge
4 Engine water temperature gauge	9 Function switches menu
5 Hydraulic oil temperature gauge	10 Language selection

**Basic operation switches**

1 Auto-decelerator	4 Buzzer cancel
2 Working mode selector	5 Wiper
3 Traveling selector	6 Window washer

**A/C operation switches**

Function switches

Basic operation switches

### Supports Efficient Operation

The main screen displays advice for promoting energy-saving operations from time to time. The operator can use the ECO guidance menu to check the operation records, ECO guidance records, average fuel consumption logs, etc.

ECO guidance

ECO guidance menu

ECO guidance records

Operation records

### Equipment Management & Monitoring System

#### Monitor function

Controller monitors engine oil level, coolant temperature, battery charge air clogging, etc. If the controller finds any abnormality, it is displayed on the LCD.

#### Maintenance function

The monitor informs replacement time of oil and filters on the LCD when the replacement interval is reached.

#### Trouble data memory function

Monitor stores abnormalities for effective troubleshooting.

Average fuel consumption logs

## KOMTRAX

*Komatsu remote monitoring and management technology provides insightful data for optimizing fleet efficiency.*

### Energy Savings Operation Report

KOMTRAX delivers the energy-savings operation report based on operating information such as fuel consumption, load summary and idling time, which helps you run the business efficiently.

This report image is an example of hydraulic excavator

### Equipment Management Support

Through the web application, a variety of search parameters are available to quickly find information about specific machines based on key factors. Moreover, KOMTRAX finds out machines with problems from your fleet and shows you through an optimal interface.

Location

Working status

Periodic maintenance

The report contents and data depend on the machine model.

### Optimum Strategy for Efficient Work

With the detailed information that KOMTRAX provides, you can manage your fleet conveniently on the web anytime, anywhere. It gives you the power to make informed decisions and long-term strategy.





# SAFETY & COMFORT

## Safety is top priority at the jobsite

### Equipped with ROPS complied cabin\*

The machine is equipped with a ROPS complied cabin as standard equipment. The ROPS cab has high shock-absorption performance, featuring excellent durability and impact strength.

Combined with the retractable seat belt, the ROPS cab protects the operator in case of toppling and against falling objects.

\*Certification pending from statutory authority



### Gas-assisted damper cylinders for opening engine hood

Gas-assisted damper cylinders help opening the engine hood with light force. Lock bar is also equipped. This equipment will support during maintenance and repair.



### Thermal guard, fan guard

Preventing direct contact with high temperature parts or the finger being caught by fan when checking around the engine, by installing thermal guards and fan guard.



### Rear view monitor system (Optional)

A new rear view monitor system display has a rear view camera image that is continuously displayed together with the gauges and important vehicle information. This enables the operator to carry out work while easily checking the surrounding area. Even if it is on another screen, it changes to the rear camera image at the same time as any operation lever is operated.

### Slip-resistant plates

Highly durable slip-resistant plates to ensure long term superior traction.



- Cab guard:
  - Front strengthened meshguard (Optional)
  - Top guard (Optional)
- Lock lever
- Pump/Engine room partition
- Large side view, rear and sidewise mirrors
- Large handrail



## Ensuring operator's comfort, it contributes to increased safety and productivity.

### Suspension seat

Suspension seat with weight adjustment function is offered as standard equipment. This seat can reduce fatigue even after long hours of operation.

### Pressurized cab

Pressurizing inside the cab minimizes the dust entering from outside. This keeps the cab clean.

### Low cab noise

With relatively low noise, you can operate without stress. Ambient noise is also reduced, thus reducing the stress of workers around.

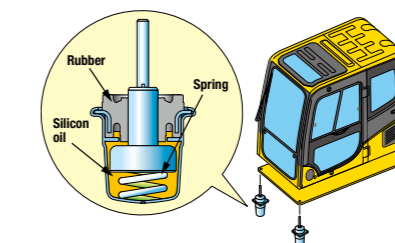

### Automatic A/C

It adjusts automatically to a comfortable temperature throughout the year, even in hot or cold areas.

### Low vibration with cab damper mounting

The cab damper mounting combined with high rigidity deck aids in vibration reduction at operator seat.

### Auxiliary



- 12 V power supply
- Magazine box
- Cool & hot box
- Luggage box





# CHOICE OF BUCKETS

# ATTACHMENT TOOLS

Komatsu buckets are engineered well with a fine profile and cutting edge to handle toughest jobs and gives best productivity. Komatsu has a line-up of various buckets for your jobsite conditions.



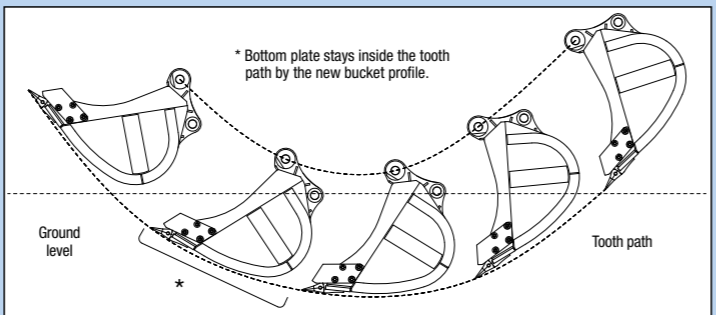

### ME Bucket

**High Productivity by Low-resistant Excavation**

The new Ideal bucket profile produces lower resistance inside & outside bucket and production will be greatly increased.

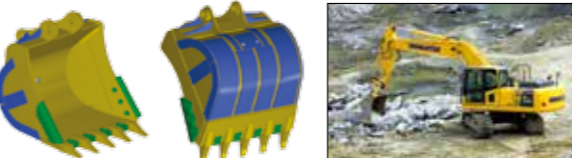

### Category and Features

Category	Load / Wear / Soil (Application)	Image
<b>General Purpose GP</b>	<p><b>Load</b> Machine power is mostly medium, but occasionally high. Bucket movements are smooth with minor shock load. Bucket penetrates easily.</p> <p><b>Wear</b> Material is lightly abrasive. Some sand may be medium abrasive.</p> <p><b>Soil</b> Mostly loose sand, gravel and finely broken materials.</p>	
<b>More Efficient "ME"</b>	<p><b>Load</b> High Productivity by low-resistant excavation. Medium, but continuous load. Wear Material is not abrasive.</p> <p><b>Soil</b> Loose soil, sand &amp; clay.</p>	
<b>Heavy Duty HD</b>	<p><b>Load</b> Machine power is high during majority of the work. Medium, but continuous shock load.</p> <p><b>Wear</b> Material is abrasive. Light scratch marks can be seen at the bucket.</p> <p><b>Soil</b> Limestone, shot rock, compact mix of sand, gravel and clay.</p> <p><b>Durability</b> Side shroud, lip shroud, wear plates were added for durability improvement.</p>	
<b>Extra Heavy Duty XHD</b>	<p><b>Load</b> Machine power is high during most of the work, often at maximum. Dynamic shock loads are frequent and machine may shake.</p> <p><b>Wear</b> Material is very abrasive. Large scratch marks are visible and, or deform metal. Works within heaps of rock with occasional un-shot rock and rock boulders.</p> <p><b>Soil</b> Granite, basalt, quartz sand, compact and sticky clay.</p> <p><b>Durability</b> Side shroud, lip shroud, wear plates were added for durability improvement.</p>	

### Bucket Line-up

Category	Capacity (m <sup>3</sup> )	Width (mm)		Weight* (kg)	Tooth Quantity	Boom + Arm (m)		
		Without Side Cutters	With Side Cutters			PC210-10M0		
						5.7+2.4	5.7+2.4	5.7+2.9
LD	1.70	1575	1575	865	-	△	△	×
GP	1.00	1242	1358	810	5	○	○	○
	1.10	1348	1463	870	5	□	○	□
ME	1.20	1200	1310	945	5	○	○	□
HD	1.00	1305	1405	932	5	○	○	×
XHD	1.00	1305	1405	1023	5	×	○	×

\* With side cutters ○: General purpose use, density up to 1.8 t/m<sup>3</sup> □: General purpose use, density up to 1.6t/m<sup>3</sup> △ Light duty work, material weight up to 1.2 t/m<sup>3</sup>  
x : Not usable

### Komatsu Genuine Attachment Tools

Komatsu recommends a wide range of attachment tools to suit customers' specific applications.

#### Hydraulic Breaker

The Hydraulic Breaker is an attachment tool used for crushing rock beds and paved surfaces, demolishing concrete structures, etc. The large gas chamber, ideal gas pressure ratio, and long-stroke piston deliver a powerful impact force. Since the breaker unit does not require an accumulator, the number of parts has been reduced, resulting in lower maintenance costs.

Model type	JTHB210-3B	
Working weight	kg	1780
Oil flow	l/min	160 - 200
Operating pressure	MPa	14 - 18
Impact rate	bpm	450 - 630
Chisel diameter	mm	∅ 135

- Anti-Blank Blow System
- Accumulator FREE design
- High Impact Energy
- High Reliability & Durability
- Low Operating Cost



#### Hydraulic Quick Coupler

Hydraulic Quick Coupler is used to facilitate frequent changes between attachments such as bucket, breaker etc., thus, saves time and reduces operator fatigue. The Twin Lock series Hydraulic Quick Coupler is completely automatic and with Automatic Blocking System makes the operation easy and safe.

- Fully Automatic (Hydraulic coupling)
- Twin Lock Mechanism
- Automatic Blocking System (ABS)
- Blocking Bar
- Lifting Eye
- High strength Cast design

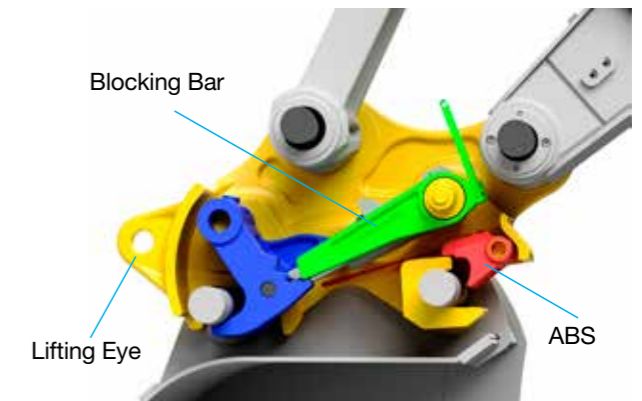



# PRODUCT SUPPORT

# SPECIFICATIONS

PC210/210LC-10M0



## Komatsu Total Support

To keep your machine available and minimize operation costs, L&T CMB (Komatsu Distributor) provides total equipment support before and after procuring the machine.

## Fleet recommendation

L&T CMB will study the customer jobsite and provide the most optimum fleet recommendation with detailed information to meet your application needs when you are considering to buy new machines or to replace the existing ones.

## Technical support

L&T CMB offers effective services for maintenance and support of Komatsu machine.

- Preventive Maintenance (PM) clinic
- Oil & Wear analysis program
- Undercarriage inspection service
- Hose inspection



## Product support

Komatsu machines are supported by L&T CMB's strong nationwide network, parts outlets and service centres.

## Parts availability

L&T CMB is available for regular and emergency requirements of the customers for supply of genuine and quality guaranteed Komatsu parts.

## Repair & maintenance service

L&T CMB offers quality repair service and periodical maintenance to the customers, while utilizing and promoting Komatsu programs.



## ENGINE

Model ..... Komatsu SAA6D107E-1  
 Type ..... Water-cooled, 4-cycle, direct injection  
 Aspiration ..... Turbocharged, aftercooled  
 Number of cylinders ..... 6  
 Bore ..... 107 mm  
 Stroke ..... 124 mm  
 Piston displacement ..... 6.69 L  
 Horsepower:  
 SAE J1995 ..... Gross 123 kW 165 HP  
 ISO 9249 / SAE J1349 ..... Net 123 kW 165 HP  
 Rated rpm ..... 2000 min<sup>-1</sup>  
 Fan drive method for radiator cooling ..... Mechanical with viscous fan clutch  
 Governor ..... All-speed control, electronic  
 Net horsepower at the maximum speed of radiator cooling fan is 117.2 kW 157.2 HP.  
 EU Stage 3A emission equivalent.



## HYDRAULICS

Type ..... HydraMind (Hydraulic Mechanical Intelligence New Design) system, closed-center system with load sensing valves and pressure compensated valves  
 Number of selectable working modes ..... 6  
 Main pump:  
 Type ..... Variable displacement piston type  
 Pumps for ..... Boom, arm, bucket, swing, and travel circuits  
 Maximum flow ..... 475 L/min  
 Supply for control circuit ..... Self-reducing valve  
 Hydraulic motors:  
 Travel ..... 2 x axial piston motor with parking brake  
 Swing ..... 1 x axial piston motor with swing holding brake  
 Relief valve setting:  
 Implement circuits ..... 37.3 MPa 380 kg/cm<sup>2</sup>  
 Travel circuit ..... 37.3 MPa 380 kg/cm<sup>2</sup>  
 Swing circuit ..... 28.9 MPa 295 kg/cm<sup>2</sup>  
 Pilot circuit ..... 3.2 MPa 33 kg/cm<sup>2</sup>  
 Hydraulic cylinders:  
 (Number of cylinders – bore x stroke x rod diameter)  
 Boom ..... 2–120 mm x 1334 mm x 85 mm  
 Arm ..... 1–135 mm x 1490 mm x 95 mm  
 Bucket for 2.41 m arm ..... 1–115 mm x 1120 mm x 80 mm  
 for 2.93 m arm ..... 1–115 mm x 1120 mm x 80 mm



## OPERATING WEIGHT (APPROXIMATE)

Operating weight including 5700 mm one-piece boom, 2410 mm arm, 1.2 m<sup>3</sup> PC210LC-10M0 and 1.0 m<sup>3</sup> PC210-10M0 backhoe bucket, rated capacity of lubricants, coolant, full fuel tank, operator, and standard equipment.

Shoes	PC210-10M0		PC210LC-10M0		PC210LC-10M0 (HD)	
	Operating Weight	Ground Pressure	Operating Weight	Ground Pressure	Operating Weight	Ground Pressure
600 mm	20900 kg	51.9 kPa 0.53 kg/cm <sup>2</sup>	22000 kg	49.0 kPa 0.50 kg/cm <sup>2</sup>	23100 kg	51.9 kPa 0.53 kg/cm <sup>2</sup>
800 mm	-	-	227000	50.9 kPa 0.52 kg/cm <sup>2</sup>	-	-



## SWING SYSTEM

Drive method ..... Hydrostatic  
 Swing reduction ..... Planetary gear  
 Swing circle lubrication ..... Grease-bathed  
 Service brake ..... Hydraulic lock  
 Holding brake/Swing lock ..... Mechanical disc brake  
 Swing speed ..... 12.4 min<sup>-1</sup>



## UNDERCARRIAGE

Center frame ..... X-frame  
 Track frame ..... Box-section  
 Seal of track ..... Sealed track  
 Track adjuster ..... Hydraulic  
 Number of shoes (Each side):  
 PC210-10M0 ..... 45  
 PC210LC-10M0 ..... 49  
 Number of carrier rollers ..... 2 each side  
 Number of track rollers (Each side):  
 PC210-10M0 ..... 7  
 PC210LC-10M0 ..... 9



## COOLANT AND LUBRICANT CAPACITY (REFILLING)

Fuel tank ..... 400 L  
 Coolant ..... 21.8 L  
 Engine ..... 23.1 L  
 Final drive (Each side) ..... 3.3 L  
 Swing drive ..... 5.3 L  
 Hydraulic tank ..... 135 L



## DRIVES AND BRAKES

Steering control ..... Two levers with pedals  
 Drive method ..... Hydrostatic  
 Maximum drawbar pull ..... 178 kN 18200 kg  
 Gradeability ..... 70%, 35°  
 Maximum travel speed: High ..... 5.5 km/h  
 (Auto-shift) Mid ..... 4.1 km/h  
 (Auto-shift) Low ..... 3.0 km/h  
 Service brake ..... Hydraulic lock  
 Parking brake ..... Mechanical disc brake





**DIMENSIONS**

Arm Length	2410 mm	2925 mm
<b>A</b> Overall length	9600 mm	9530 mm
<b>B</b> Length on ground (Transport): PC210-10M0 PC210LC-10M0	5700 mm 5885 mm	- 5000 mm
<b>C</b> Overall height (To top of boom)	3190 mm	2970 mm

Model	PC210-10M0	PC210LC-10M0
<b>D</b> Overall width	2800 mm	2980 mm
<b>E</b> Overall height (To top of cab)	3045 mm	3045 mm
<b>F</b> Ground clearance, counterweight	1085 mm	1085 mm
<b>G</b> Ground clearance (Minimum)	440 mm	440 mm
<b>H</b> Tail swing radius	2900 mm	2900 mm
<b>I</b> Track length on ground	3275 mm	3655 mm
<b>J</b> Track length	4070 mm	4450 mm
<b>K</b> Track gauge	2200 mm	2380 mm
<b>L</b> Width of crawler	2800 mm	2980 mm
<b>M</b> Shoe width	600 mm	600 mm
<b>N</b> Grouser height	26 mm	26 mm
<b>O</b> Machine cab height	2095 mm	2095 mm
<b>P</b> Machine cab width	2710 mm	2710 mm
<b>Q</b> Distance, swing center to rear end	2860 mm	2860 mm

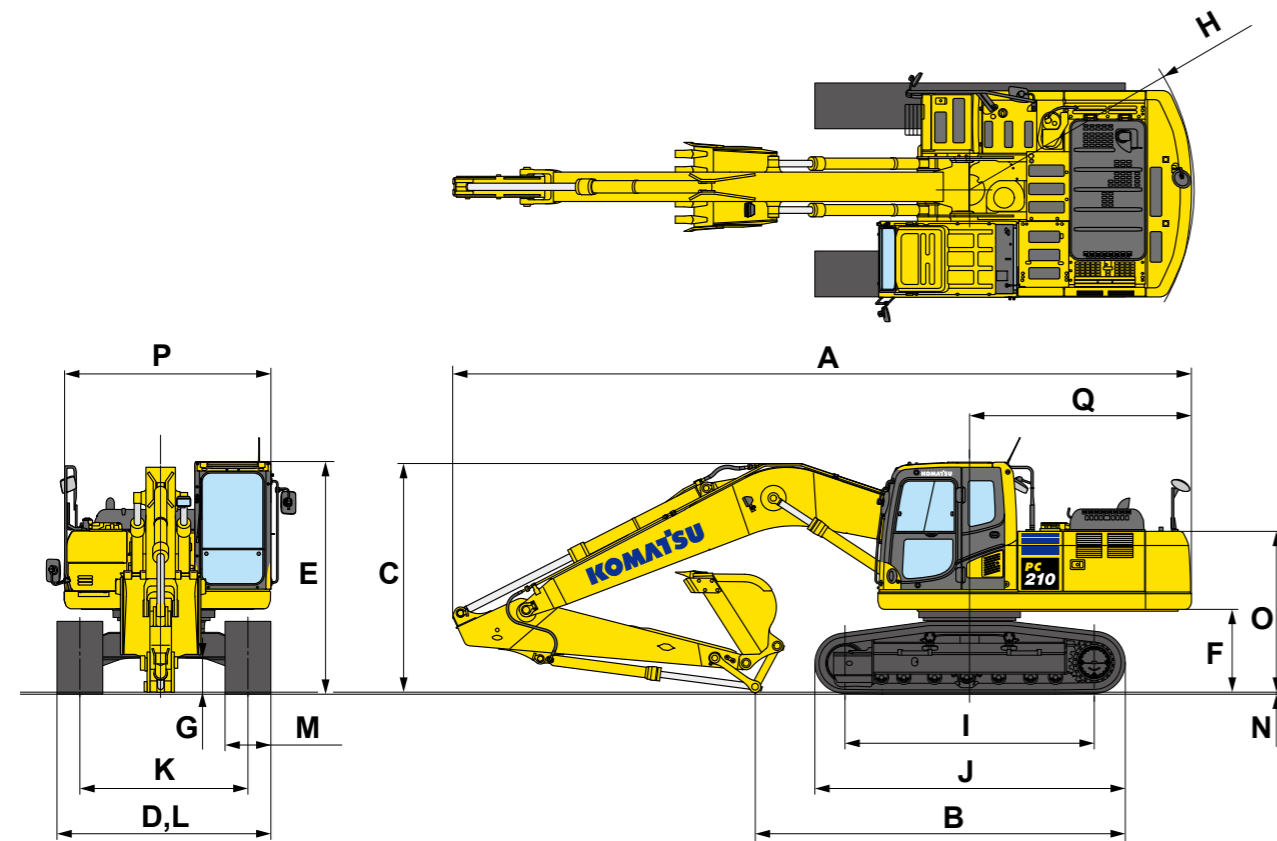

**WORKING RANGE**

Arm Length	2410 mm	2925 mm	
<b>A</b> Max. digging height	9830 mm	10000 mm	
<b>B</b> Max. dumping height	6960 mm	7110 mm	
<b>C</b> Max. digging depth	6000 mm	6620 mm	
<b>D</b> Max. vertical wall digging depth	5080 mm	5980 mm	
<b>E</b> Max. digging reach	9390 mm	9875 mm	
<b>F</b> Max. digging reach at ground level	9195 mm	9700 mm	
<b>G</b> Min. swing radius	3080 mm	3040 mm	
<b>SAE J 1179 Rating</b>	Bucket digging force at power max.	138 kN 14100 kg	138 kN 14100 kg
	Arm crowd force at power max.	124 kN 12600 kg	101 kN 10300 kg
<b>ISO 6015 Rating</b>	Bucket digging force at power max.	149 kN 15200 kg	149 kN 15200 kg
	Arm crowd force at power max.	127 kN 13000 kg	108 kN 11000 kg

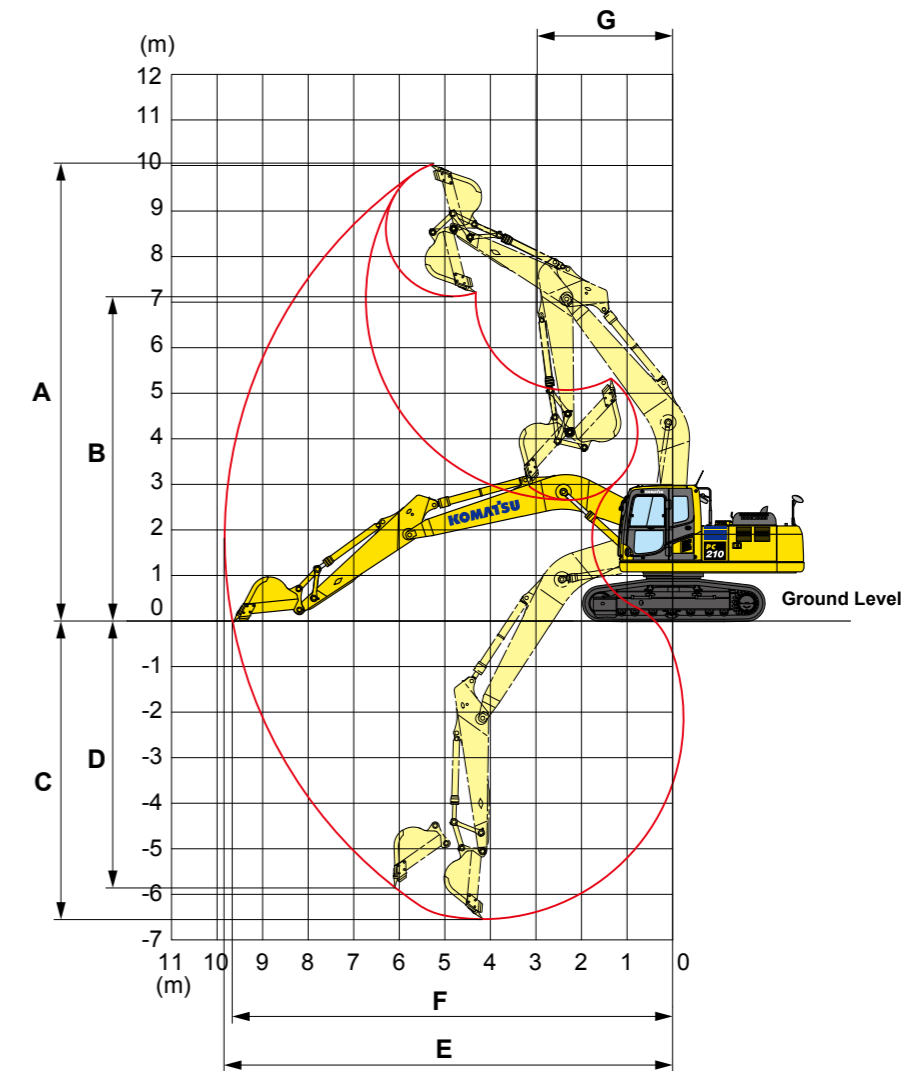





**LIFTING CAPACITY WITH LIFTING MODE**

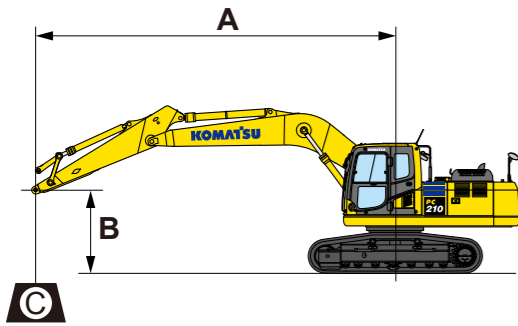

A: Reach from swing center  
 B: Arm top pin height  
 C: Lifting capacity  
 Cf: Rating over front  
 Cs: Rating over side  
 ⊕: Rating at maximum reach

Conditions:  
 • 5700 mm one-piece boom  
 • Shoe width:  
 — PC210-10M0 600 mm triple grouser

PC210-10M0		Arm: 2410 mm		Without bucket		Shoe: 600 mm triple grouser							
B	A	⊕ MAX		7.5 m		6.0 m		4.5 m		3.0 m		1.5 m	
		Cf	Cs	Cf	Cs	Cf	Cs	Cf	Cs	Cf	Cs	Cf	Cs
7.5 m	5.49 m	*5900 kg	5250 kg										
6.0 m	6.71 m	5500 kg	3750 kg			*5800 kg	4550 kg	*6050 kg	*6050 kg				
4.5 m	7.44 m	4600 kg	3100 kg			*6300 kg	4400 kg	*7400 kg	6800 kg	*10200 kg	*10200 kg		
3.0 m	7.81 m	4150 kg	2800 kg	4450 kg	3000 kg	6250 kg	4200 kg	*9300 kg	6300 kg				
1.5 m	7.88 m	4000 kg	2700 kg	4350 kg	2900 kg	6000 kg	3950 kg	9250 kg	5850 kg				
0 m	7.67 m	4150 kg	2750 kg	4250 kg	2850 kg	5850 kg	3850 kg	9050 kg	5650 kg				
-1.5 m	7.13 m	4550 kg	3050 kg			5800 kg	3800 kg	9000 kg	5650 kg	*12200 kg	10750 kg		
-3.0 m	6.19 m	5650 kg	3700 kg			5900 kg	3850 kg	9100 kg	5750 kg	*14300 kg	10950 kg		

\* Load is limited by hydraulic capacity rather than tipping. Ratings are based on ISO standard No.10567. Rated loads do not exceed 87% of hydraulic lift capacity or 75% of tipping load.

Condition:  
 • Shoe width:  
 — PC210LC-10M0 600 mm triple grouser

PC210LC-10M0		Arm: 2410 mm		Without bucket		Shoe: 600 mm triple grouser							
B	A	⊕ MAX		7.5 m		6.0 m		4.5 m		3.0 m		1.5 m	
		Cf	Cs	Cf	Cs	Cf	Cs	Cf	Cs	Cf	Cs	Cf	Cs
7.5 m	5.49 m	*5900 kg	5850 kg										
6.0 m	6.71 m	*5500 kg	4200 kg			*5800 kg	5050 kg	*6050 kg	*6050 kg				
4.5 m	7.44 m	5400 kg	3500 kg			*6300 kg	4900 kg	*7400 kg	*7400 kg	*10200 kg	*10200 kg		
3.0 m	7.81 m	4900 kg	3150 kg	5250 kg	3350 kg	*7150 kg	4700 kg	*9300 kg	7100 kg				
1.5 m	7.88 m	4800 kg	3050 kg	5150 kg	3250 kg	7200 kg	4450 kg	*10900 kg	6650 kg				
0 m	7.67 m	4900 kg	3100 kg	5050 kg	3200 kg	7000 kg	4350 kg	11100 kg	6450 kg				
-1.5 m	7.13 m	5450 kg	3450 kg			7000 kg	4300 kg	11050 kg	6450 kg	*12200 kg	*12200 kg		
-3.0 m	6.19 m	6750 kg	4200 kg			7050 kg	4350 kg	*10400 kg	6550 kg	*14300 kg	12700 kg		

PC210LC-10M0		Arm: 2925 mm		Without bucket		Shoe: 600 mm triple grouser							
B	A	⊕ MAX		7.5 m		6.0 m		4.5 m		3.0 m		1.5 m	
		Cf	Cs	Cf	Cs	Cf	Cs	Cf	Cs	Cf	Cs	Cf	Cs
7.5 m	6.15 m	*3850 kg	*3850 kg			*4450 kg	*4450 kg						
6.0 m	7.26 m	*3600 kg	*3600 kg			*5150 kg	5100 kg						
4.5 m	7.93 m	*3550 kg	3100 kg	5300 kg	3400 kg	*5750 kg	4900 kg	*6500 kg	*6500 kg				
3.0 m	8.29 m	*3700 kg	2800 kg	5200 kg	3300 kg	*6600 kg	4650 kg	*8450 kg	7150 kg				
1.5 m	8.36 m	*3950 kg	2700 kg	5050 kg	3200 kg	7100 kg	4400 kg	*10250 kg	6600 kg				
0 m	8.15 m	4400 kg	2750 kg	4950 kg	3100 kg	6900 kg	4200 kg	10950 kg	6300 kg	*7000 kg	*7000 kg		
-1.5 m	7.65 m	4800 kg	3000 kg	4950 kg	3050 kg	6800 kg	4150 kg	10850 kg	6250 kg	*11450 kg	*11450 kg	*7250 kg	*7250 kg
-3.0 m	6.78 m	5750 kg	3550 kg			6850 kg	4200 kg	*10700 kg	6300 kg	*15200 kg	12300 kg	*11900 kg	*11900 kg
-4.5 m	5.37 m	*7000 kg	5100 kg					*8700 kg	6550 kg	*12200 kg	*12200 kg		

\* Load is limited by hydraulic capacity rather than tipping. Ratings are based on ISO standard No.10567. Rated loads do not exceed 87% of hydraulic lift capacity or 75% of tipping load.



**STANDARD EQUIPMENT**

**ENGINE**

- Air pre-cleaner
- Automatic engine warm-up system
- Coolant filter
- Dry type air cleaner, double element
- Engine, Komatsu SAA6D107E-1
- Engine overheat prevention system
- Fan clutch
- Radiator and oil cooler dust proof net
- Large capacity fuel pre-filter

**ELECTRICAL SYSTEM**

- Alternator, 24 V/60 A, brushless
- Auto-decelerator
- Batteries, 2 X 12 V/88 Ah
- Battery disconnect switch with operation lamp
- Starting motor, 24 V/4.5 kW
- Working light, 2 (Boom and R.H.)

**HYDRAULIC SYSTEM**

- Boom holding valve
- Clogging sensor for hydraulic return filter
- Power maximizing system
- Pressure Proportional Control (PPC) hydraulic control system
- Working mode selection system
- Service Valve
- Ready to mount Quick Coupler

**GUARDS AND COVERS**

- Fan guard structure
- Revolving frame deck guard (Only in PC210LC-10M0)

**UNDERCARRIAGE**

- Hydraulic track adjusters (Each side)
- Track guiding guard, center section
- Track roller
- PC210-10M0: 7 each side
- PC210LC-10M0: 9 each side
- Track shoe
- PC210-10M0: 600 mm triple grouser
- PC210LC-10M0: 600 mm triple grouser

**OPERATOR ENVIRONMENT**

- 12 V power supply
- Auto A/C with defroster
- AUX equipped with radio
- Equipment Management Monitoring System
- Large high resolution LCD monitor
- Rear view mirrors (R.H., L.H., rear, sidewise)
- Suspension seat

**SERVICING EQUIPMENT**

- Oil sampling port (Engine & hydraulic)

**OTHER EQUIPMENT**

- Blow-by sensor
- Counterweight
- Electric horn
- KOMTRAX
- Rear reflector
- Slip-resistant plates



**OPTIONAL EQUIPMENT**

**ELECTRICAL SYSTEM**

- Amber beacon lamp on cab roof
- Working lights
- 2 on cab
- 1 on counterweight

**HYDRAULIC SYSTEM**

- Clogging sensor for breaker return filter
- Inline filter

**GUARDS AND COVERS**

- Heavy duty revolving frame undercover

**UNDERCARRIAGE**

- Track frame undercover
- Track roller guards (Full length)
- Triple Grouser Shoes
- 800mm track (PC210LC-10M0)

**OPERATOR ENVIRONMENT**

- Bolt-on top guard
- Cab accessories
- Rain visor
- Sun visor

- Cab front guard
- Full height guard
- Rear view monitor system
- ROPS cab (ISO 12117-2)
- Top guard level 2 (ISO 10262)
- Front guard level 2 (ISO 10262)

**WORK EQUIPMENT**

- Arms
- 2925 mm arm assembly (Only in PC210LC-10M0)

**ATTACHMENTS**

- Hydraulic breaker
- Quick coupler

**SERVICING EQUIPMENT**

- Preventive Maintenance (PM) service connector

For lead time, please consult your distributor.



